

Onsite Tiered Permitting - Flowchart

(For non-RCRA or exempt hazardous waste facilities conducting onsite treatment.)

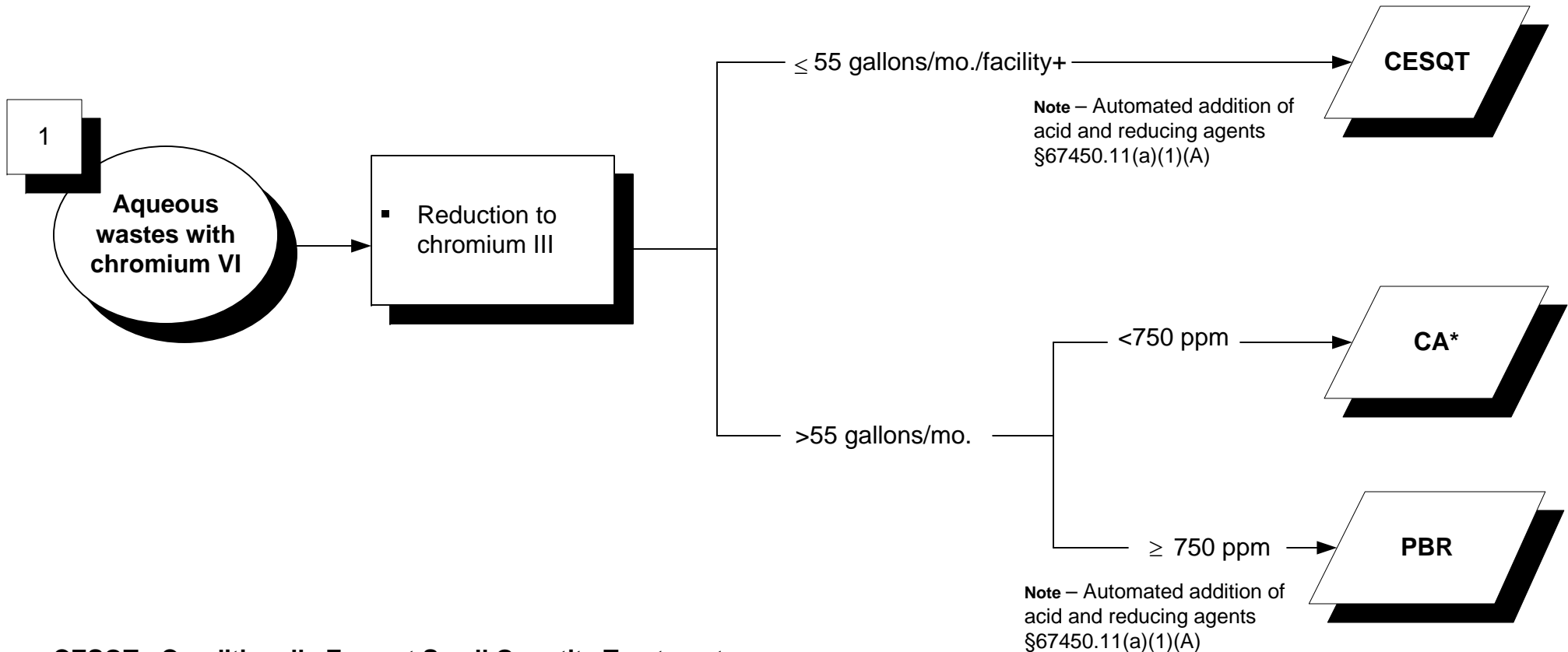

CESQT - Conditionally Exempt Small Quantity Treatment

(Health and Safety Code (HSC § 25201.5(a))

+A CESQT facility can only treat a total volume of not more than 55 gallons/month

CESW - Conditionally Exempt Specified Wastestream (HSC § 25201.5(c))

CEL - Conditionally Exempt-Limited (HSC § 25201.14)

CECL - Conditionally Exempt Commercial Laundries (HSC § 25144.6(c))

CA - Conditional Authorization (HSC § 25200.3)

PBR - Permit by Rule (Title 22, CCR, Div. 4.5, Chapter 45)

*Must be hazardous solely due to this characteristic

In tanks or containers, such as breathing and evaporation through vents and floating roofs, without the addition of pressure, chemicals, or heat other than sunlight or ambient room lighting or heating.
[HSC, § 25123.5 (b)(1)(A) and (b)(2)(D)]

**NO
authorization
required**

Evaporation

- pH Adjustment (≥ 2 or ≤ 12.5)
- Precipitation or Crystallization
- Ion Exchange
- Reverse Osmosis
- Metallic Replacement
- Plating onto an Electrode
- Electrodialysis
- Electrowinning or Electrolytic recovery
- Chemical Stabilization
- Adsorption

Phase Separation

During storage or accumulation in tanks or containers only if the separation is unaided by the addition of heat or chemical.** [HSC, § 25123.5 (b)(1)(A) and (b)(2)(B)]

**NO
authorization
required**

2a
Aqueous wastes with metals listed in T22 § 66261.24 (a)(2)

≤ 55 gallons/mo./facility+ → **CESQT**

>55 gallons/mo. $>1,400$ ppm → **PBR**

**Containers must be closed except when adding/removing hazardous wastes (T22, § 66265.173)

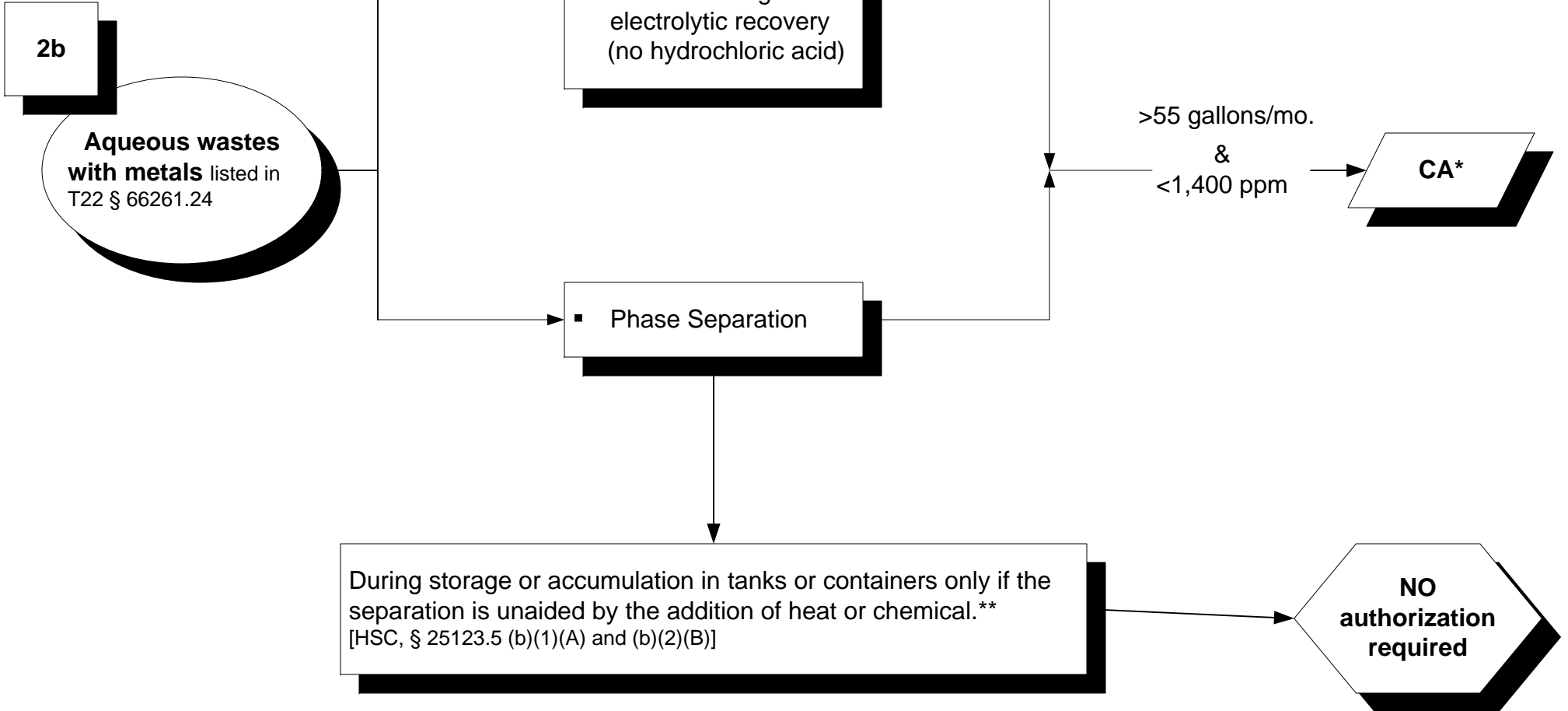

*Must be hazardous solely due to this characteristic

**Containers must be closed except when adding/removing hazardous wastes (T22, § 66265.173)

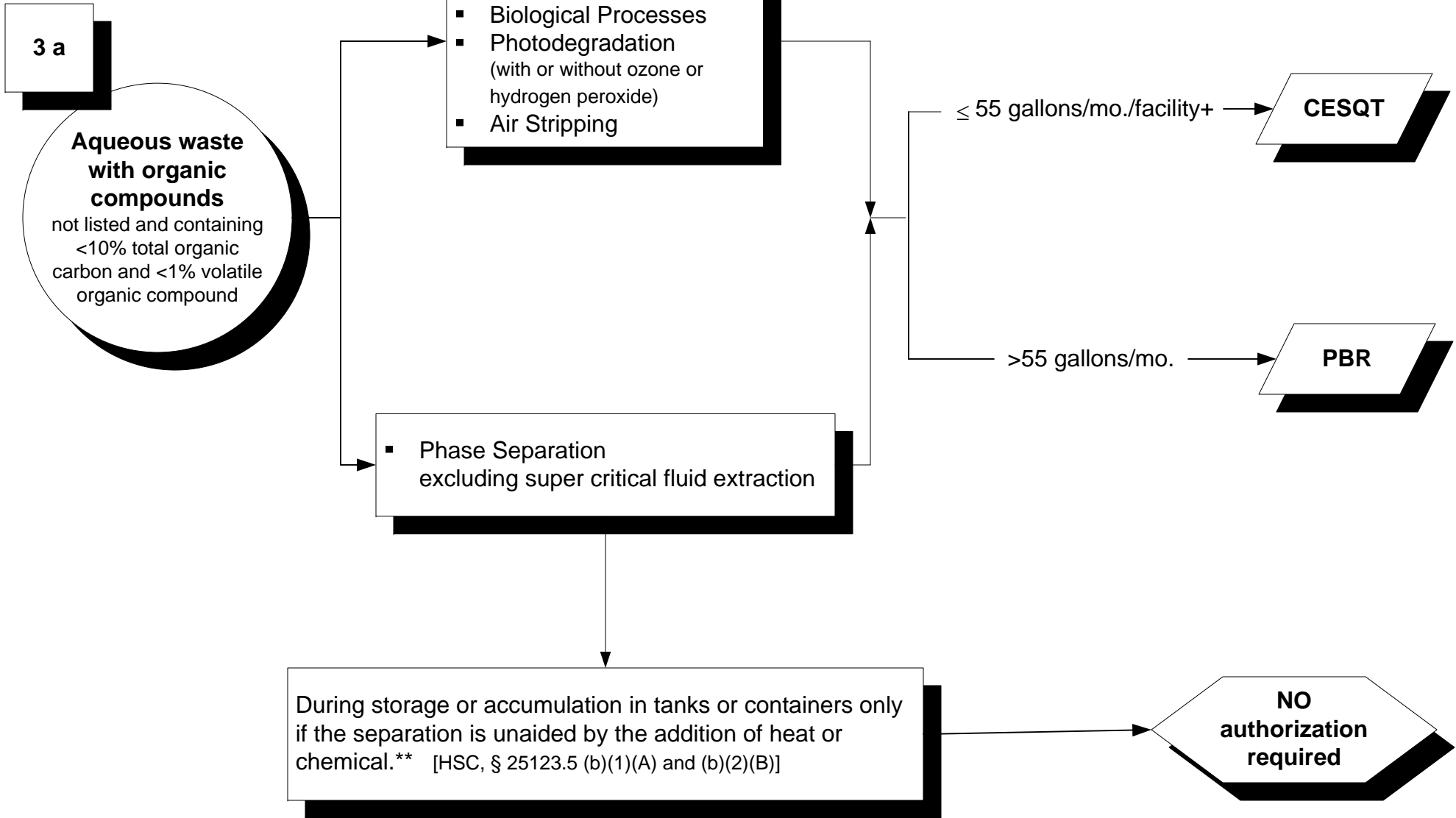

*Must be hazardous solely due to this characteristic

**Containers must be closed except when adding/removing hazardous wastes (T22, § 66265.173)

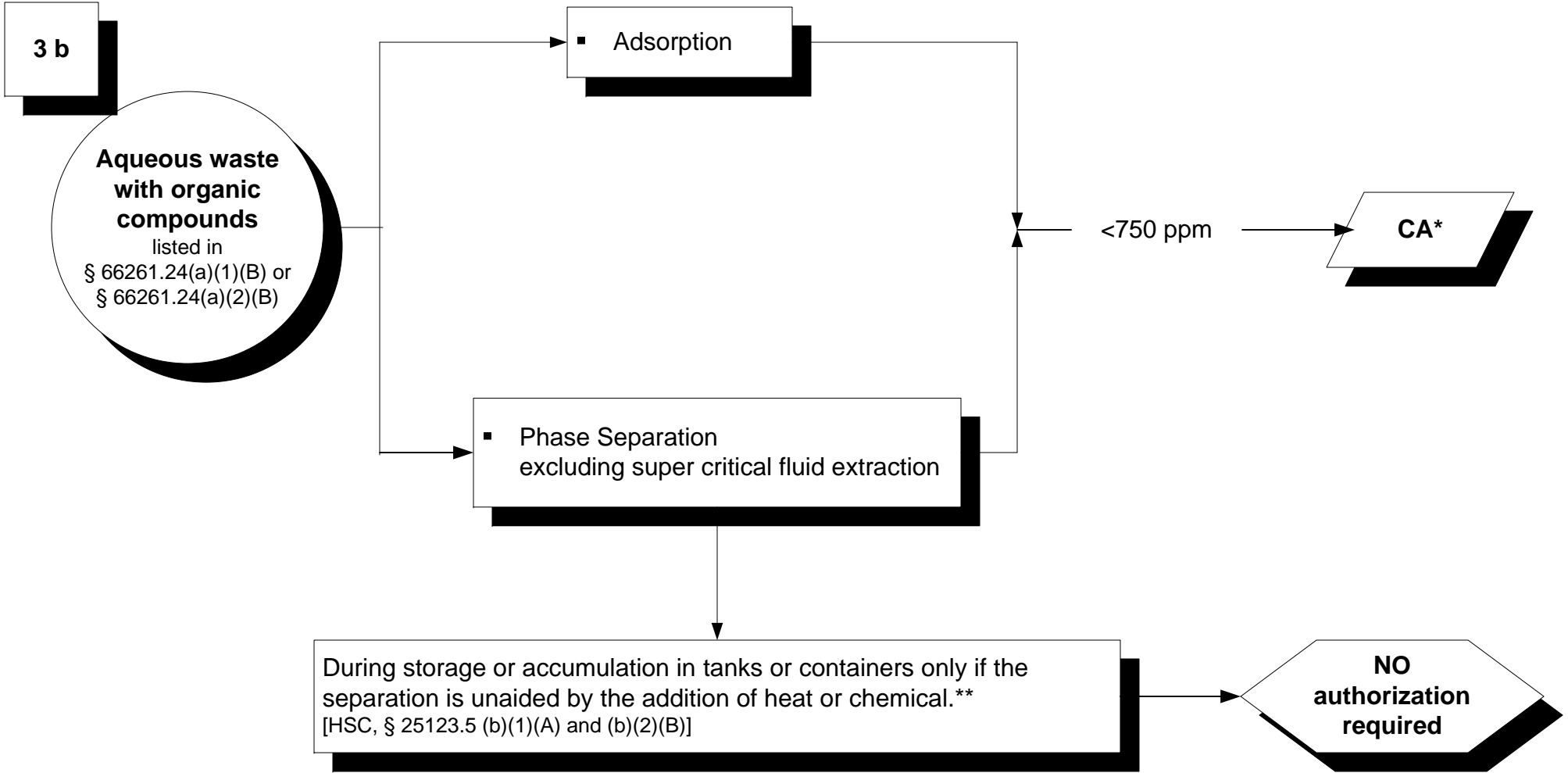

*Must be hazardous solely due to this characteristic

**Containers must be closed except when adding/removing hazardous wastes (T22, § 66265.173)

In tanks or containers, such as breathing and evaporation through vents and floating roofs, without the addition of pressure, chemicals, or heat other than sunlight or ambient room lighting or heating.

[HSC, § 25123.5 (b)(1)(A) and (b)(2)(D)]

**NO
authorization
required**

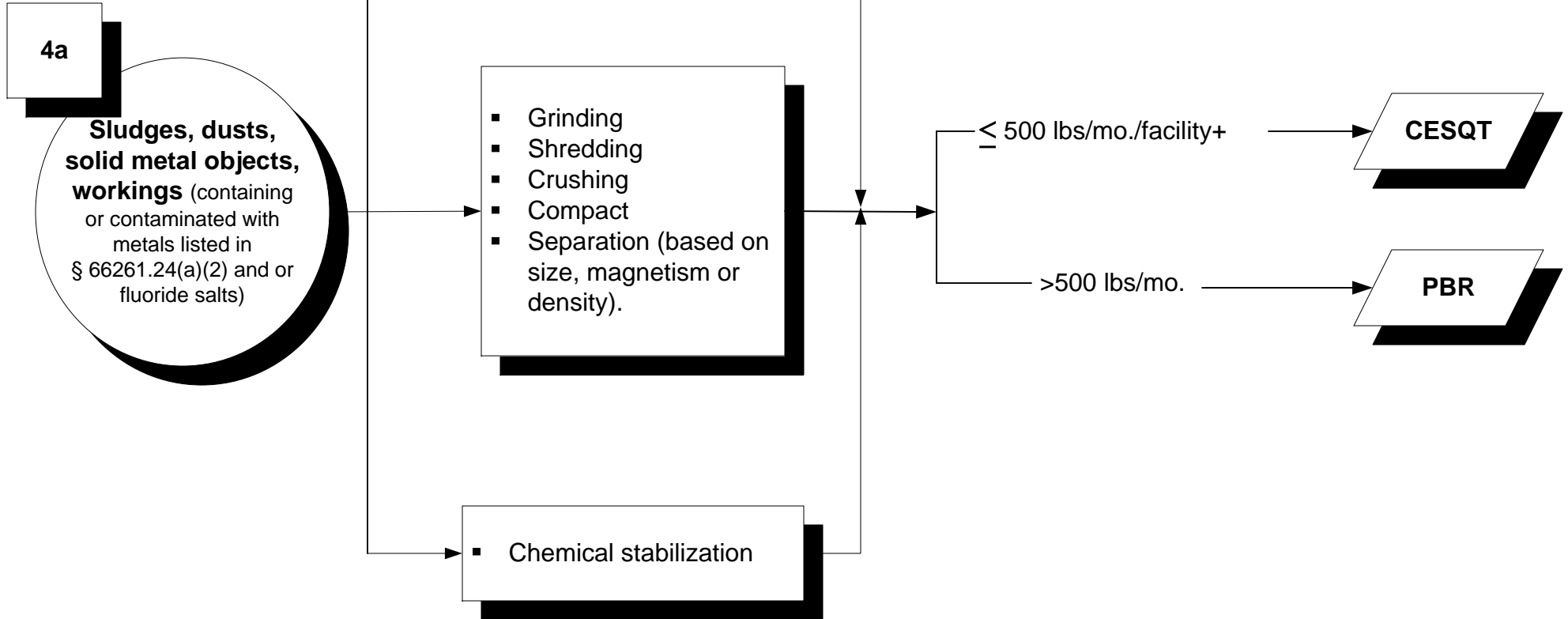

In tanks or containers, such as breathing and evaporation through vents and floating roofs, without the addition of pressure, chemicals, or heat other than sunlight or ambient room lighting or heating.
[HSC, § 25123.5 (b)(1)(A) and (b)(2)(D)]

**NO
authorization
required**

▪ Drying (to remove water)

- Centrifuge
- Gravity Settling
- Grinding
- Shredding
- Crushing
- Compact
- Separation (based on size, magnetism or density).

▪ Filtration

≤ 45,000 lbs/mo.

CA*

Sieving or filtering liquid hazardous waste to remove solid fractions, without added heat, chemicals, or pressure, as the waste is added to or removed from a storage or accumulation tank or container. For this activity, sieving or filtering does not include adsorption, reverse osmosis, or ultrafiltration.
[HSC, § 25123.5 (b)(1)(A) and (b)(2)(B)]

**NO
authorization
required**

4b

Wastewater treatment sludges, solid metal objects, metal workings
containing or contaminated with metals and Dusts containing ≤750 ppm metal (except asbestos)
(§ 66261.24(a)(1)(B) or § 66261.24(a)(2)(A))

*Must be hazardous solely due to this characteristic

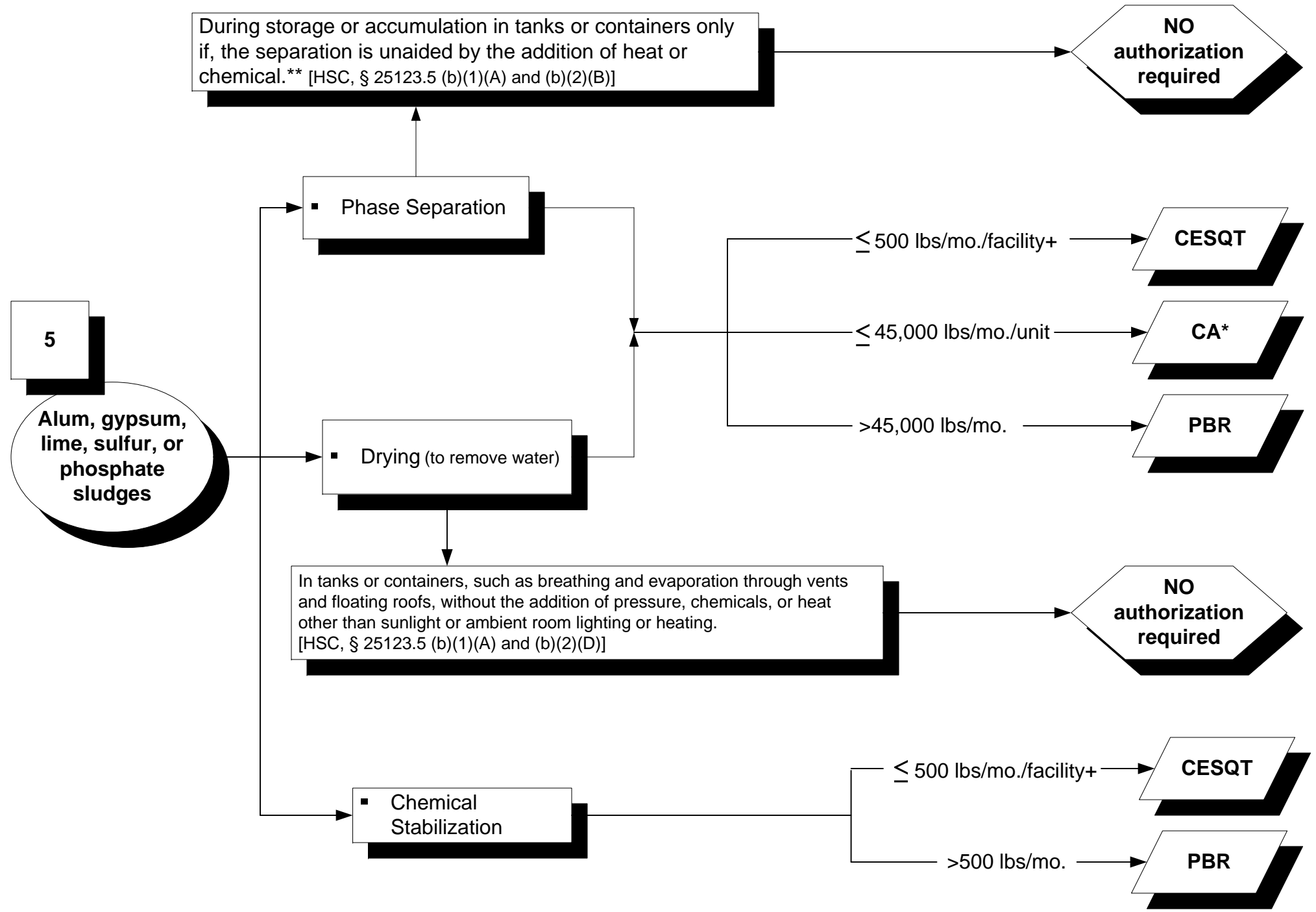

*Must be hazardous solely due to this characteristic

**Containers must be closed except when adding/removing hazardous wastes (T22, § 66265.173)

During storage or accumulation in tanks or containers only if, the separation is unaided by the addition of heat or chemical.** [HSC, § 25123.5 (b)(1)(A) and (b)(2)(D)]

NO authorization required

6

Waste
listed in § 66261.120, which meets the criteria and requirements for classification as special wastes in T22, § 66261.122 and § 66261.124

Phase Separation

Screening to separate components (based on size)
Separation (based on size, magnetism or density)

Drying (to remove water)

In tanks or containers, such as breathing and evaporation through vents and floating roofs, without the addition of pressure, chemicals, or heat other than sunlight or ambient room lighting or heating.
[HSC, § 25123.5 (b)(1)(A) and (b)(2)(D)]

Chemical Stabilization

≤ 500 lbs/mo./facility+

CESQT

≤ 750 ppm and
≤ 45,000 lbs/mo./unit

CA*

>45,000 lbs/mo.

PBR

NO authorization required

≤ 500 lbs/mo./facility+

CESQT

>500 lbs/mo.

PBR

*Must be hazardous solely due to this characteristic

**Containers must be closed except when adding/removing hazardous wastes (T22, § 66265.173)

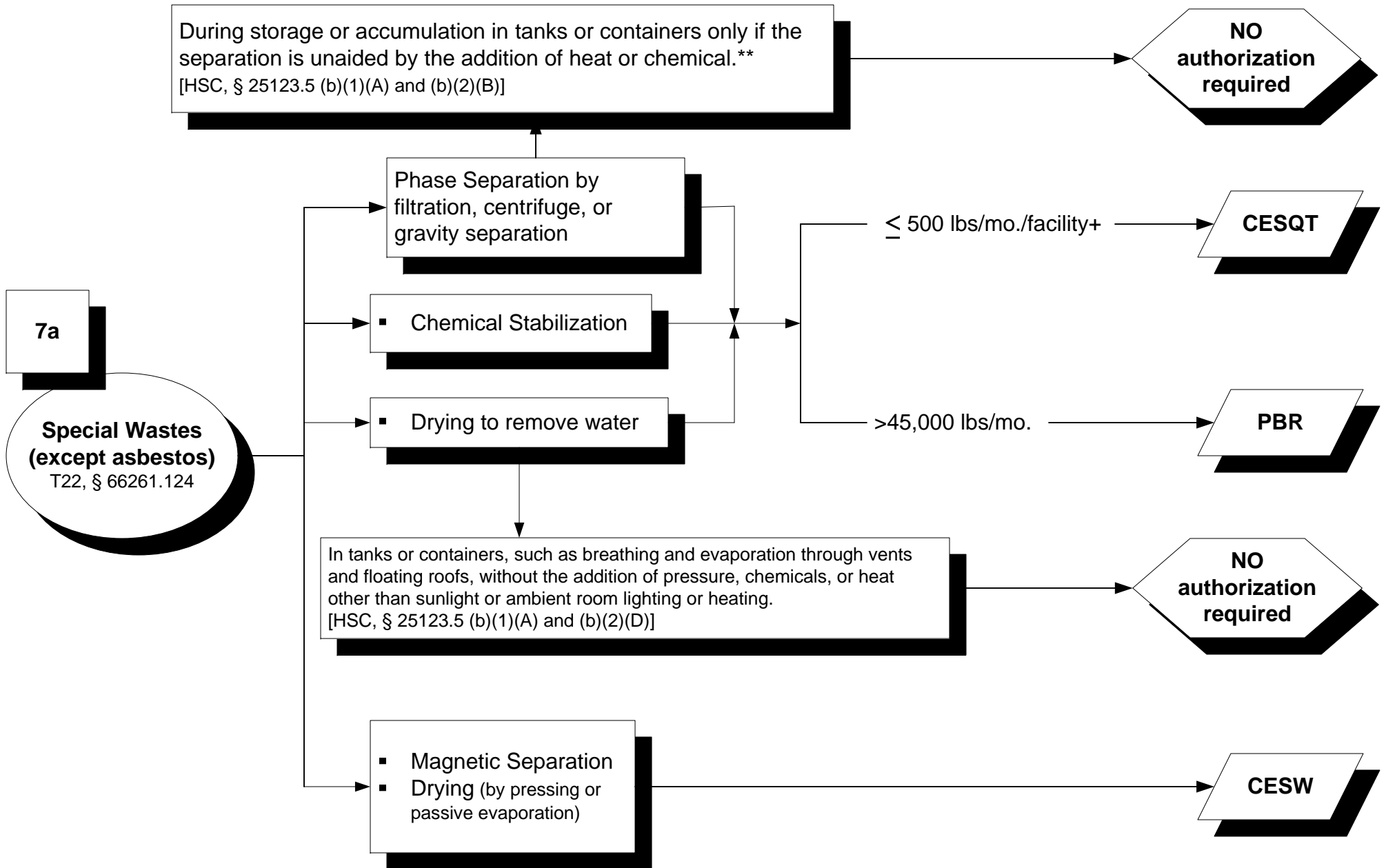

**Containers must be closed except when adding/removing hazardous wastes (T22, § 66265.173)

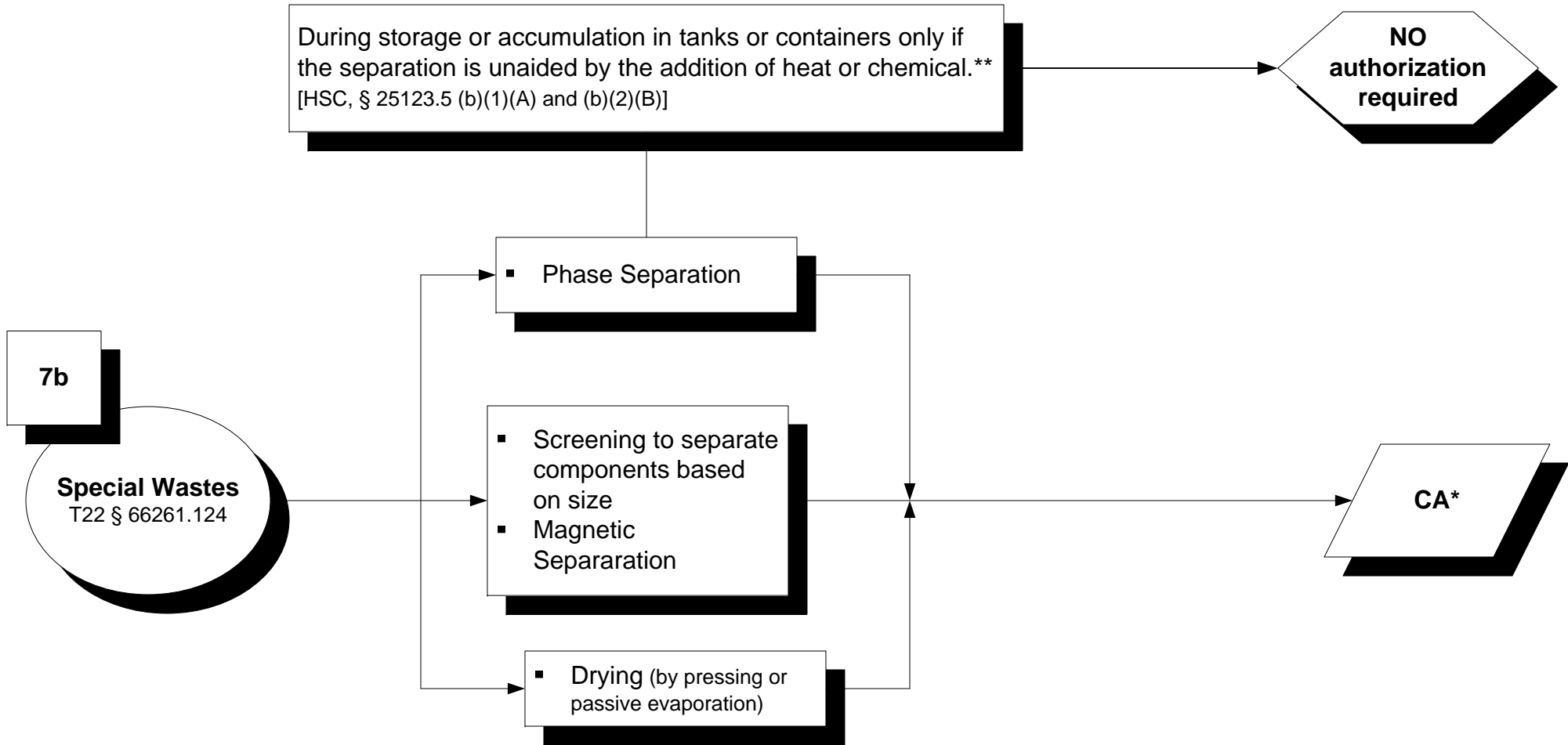

*Must be hazardous solely due to this characteristic

**Containers must be closed except when adding/removing hazardous wastes (T22, § 66265.173)

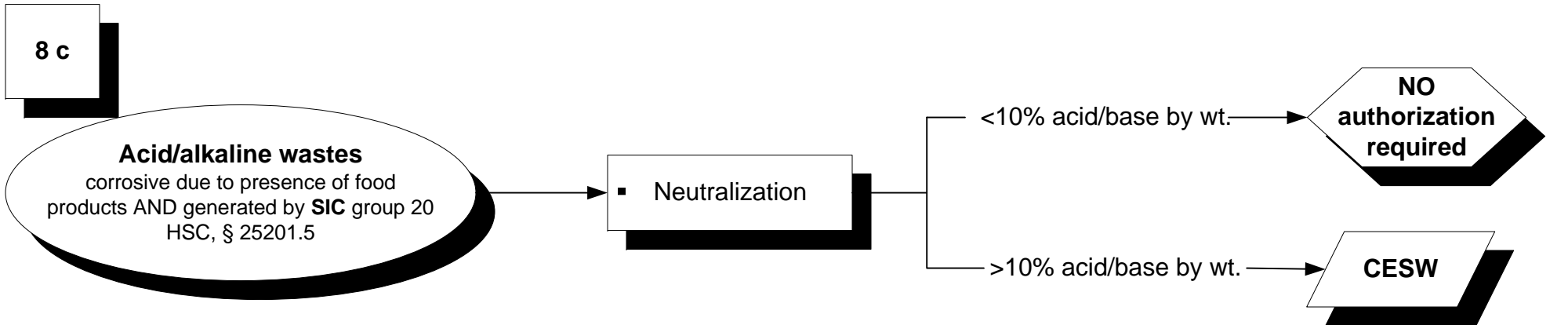
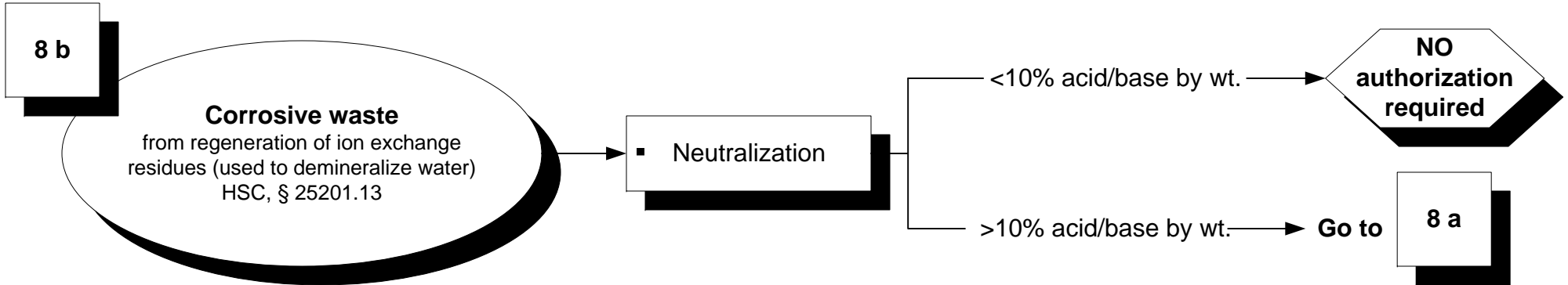
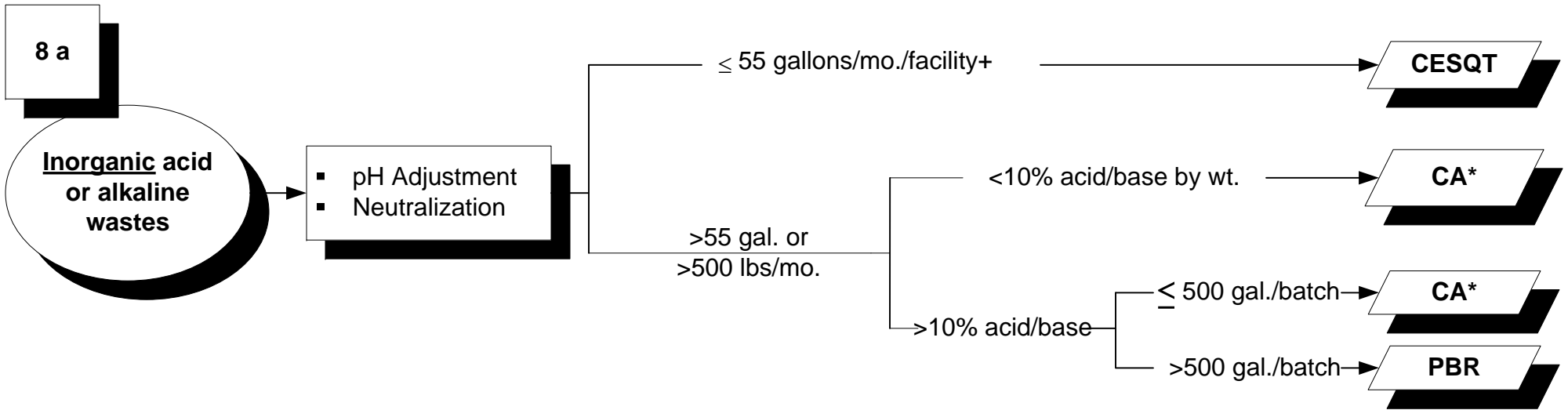

*Must be hazardous solely due to this characteristic.

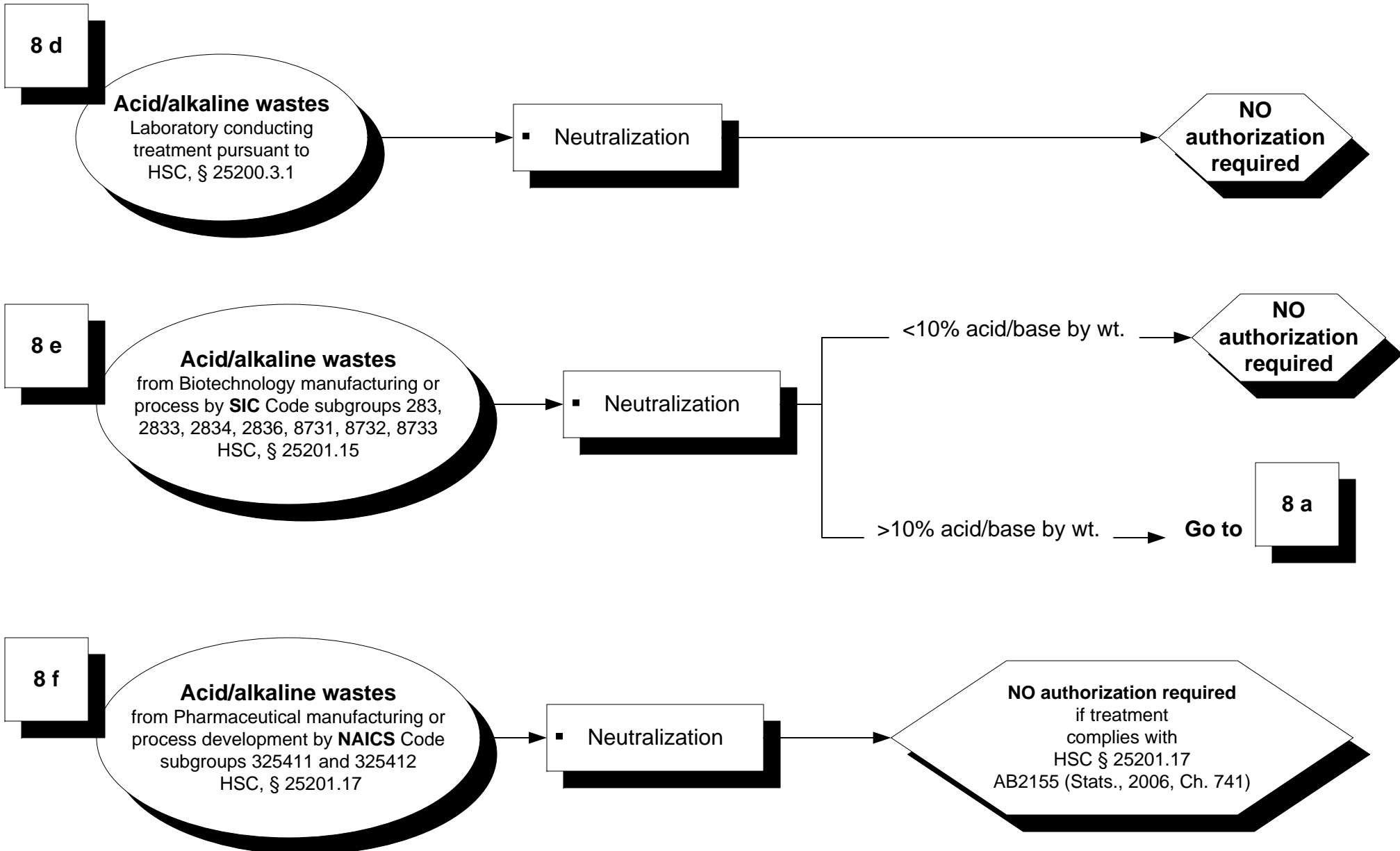

North American Industry Classification System (NAICS) was adopted in 1997 to replace the Standard Industrial Classification (SIC) system

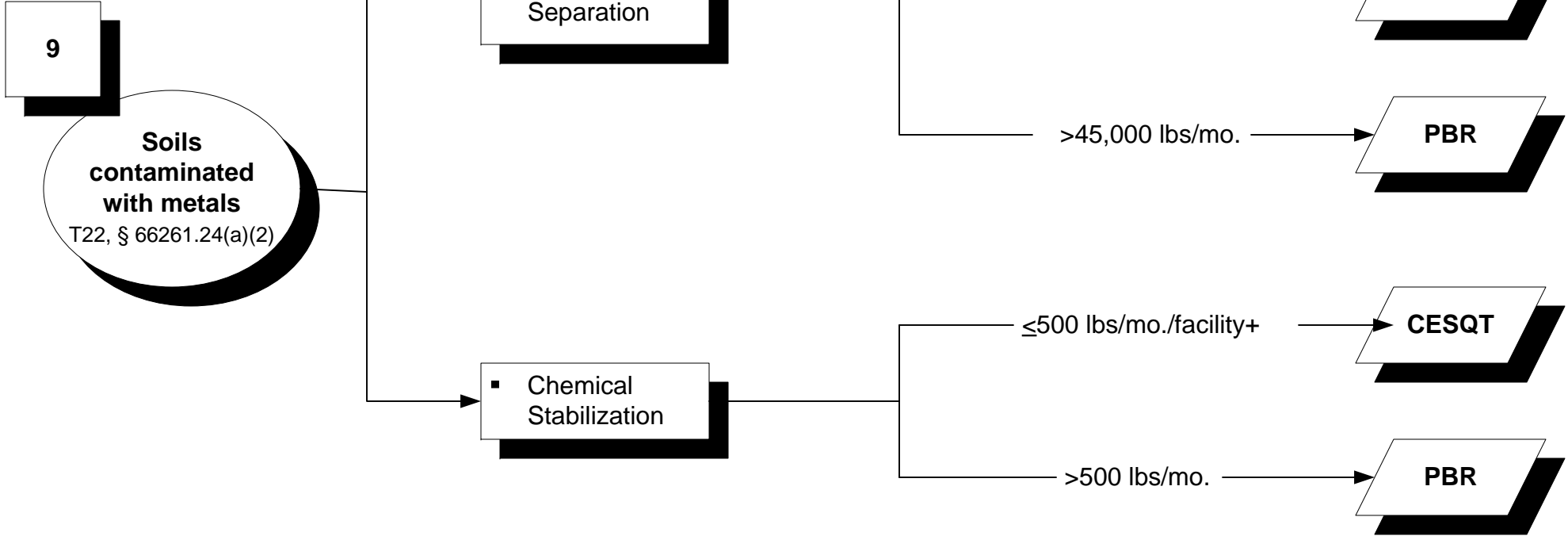

*Must be hazardous solely due to this characteristic

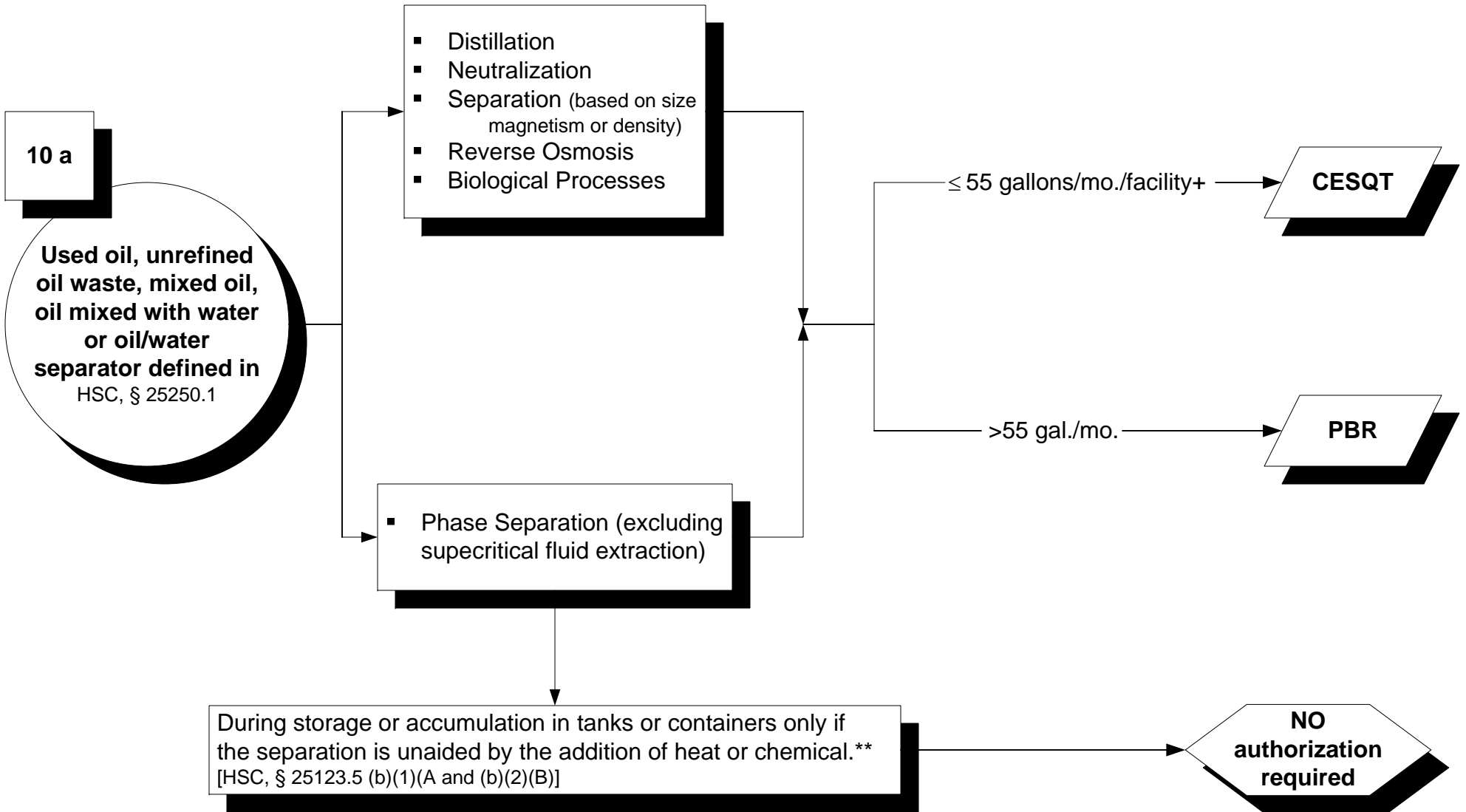

**Containers must be closed except when adding/removing hazardous wastes (T22, § 66265.173)

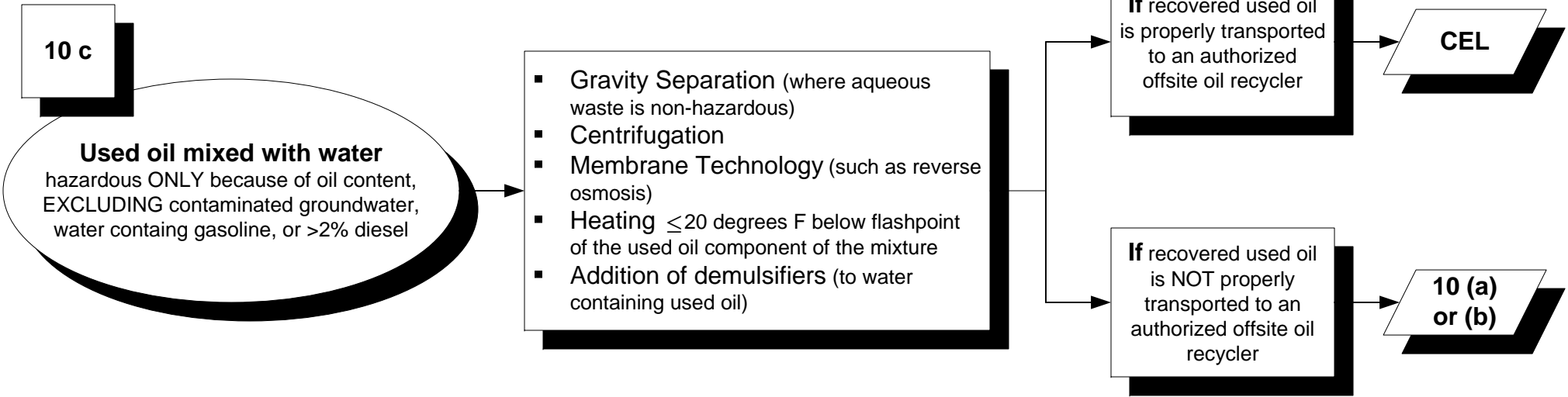
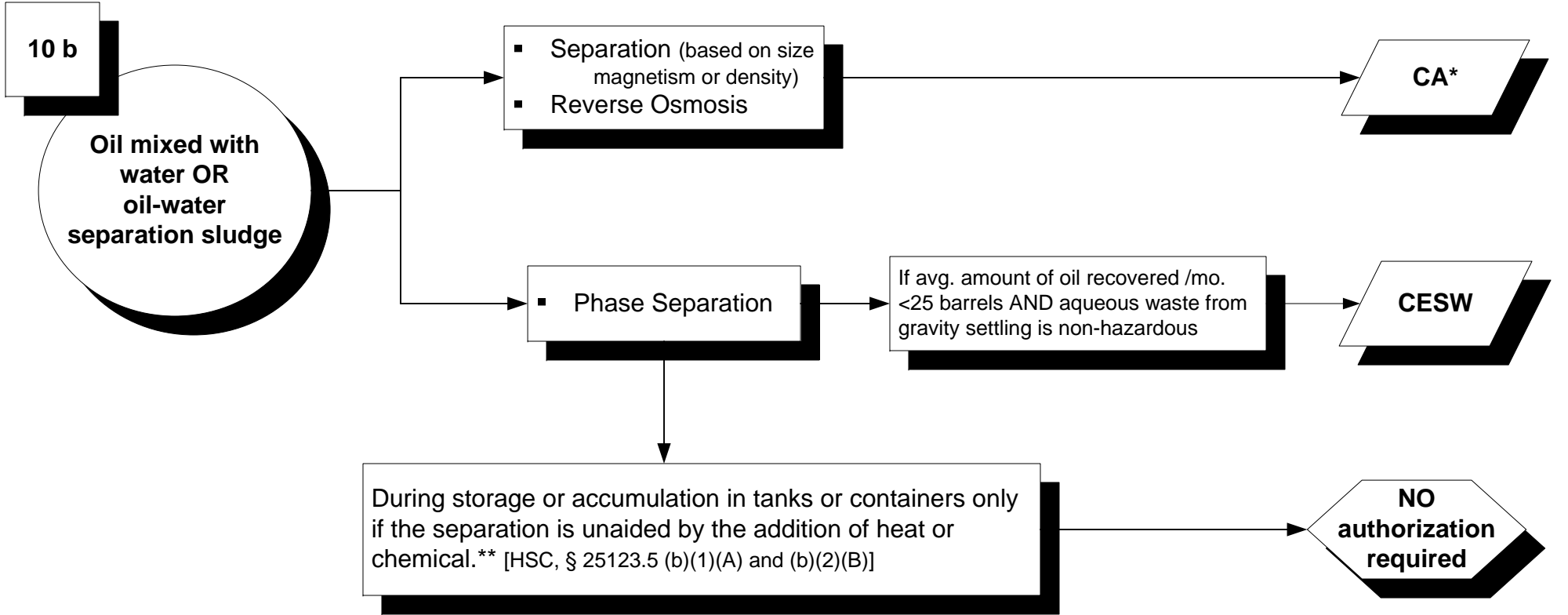

*Must be hazardous solely due to this characteristic.

**Containers must be closed except when adding/removing hazardous wastes (T22, § 66265.173)

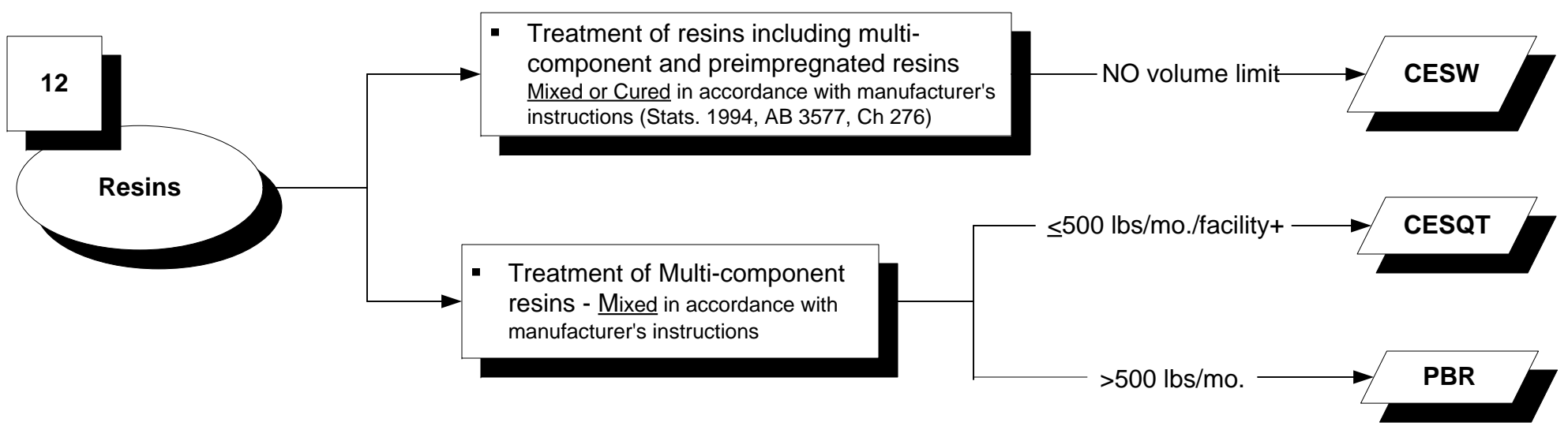
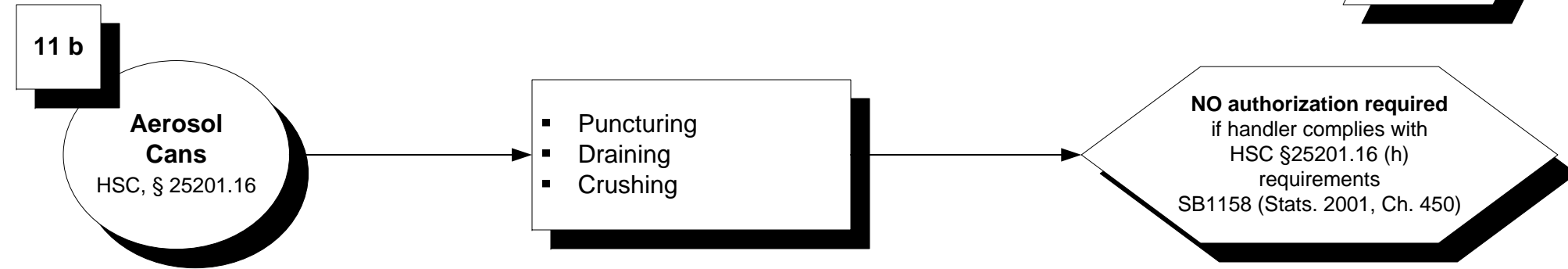
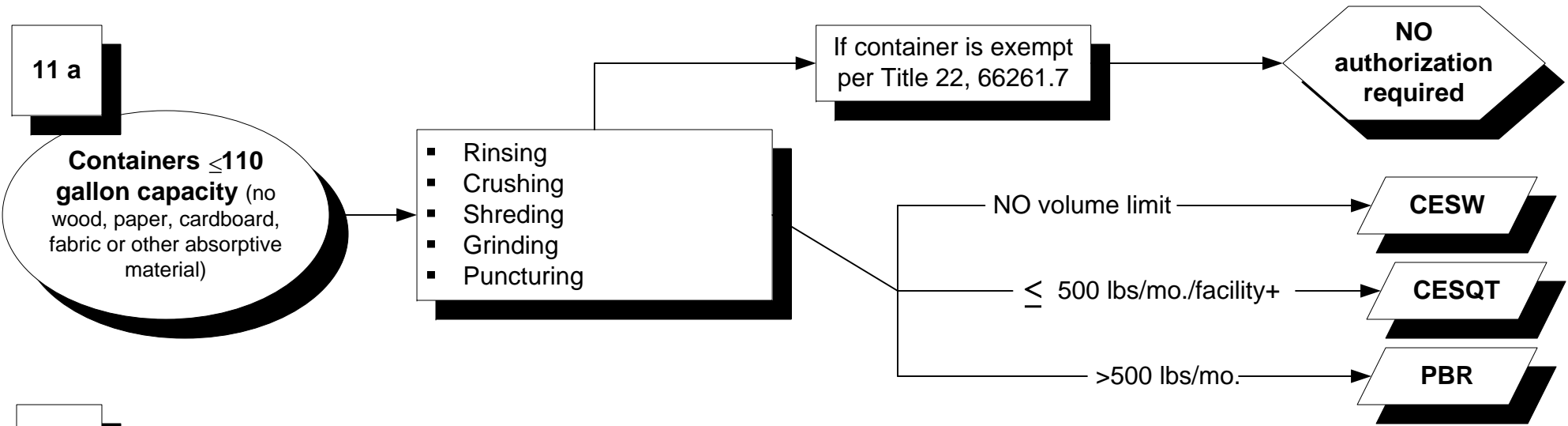

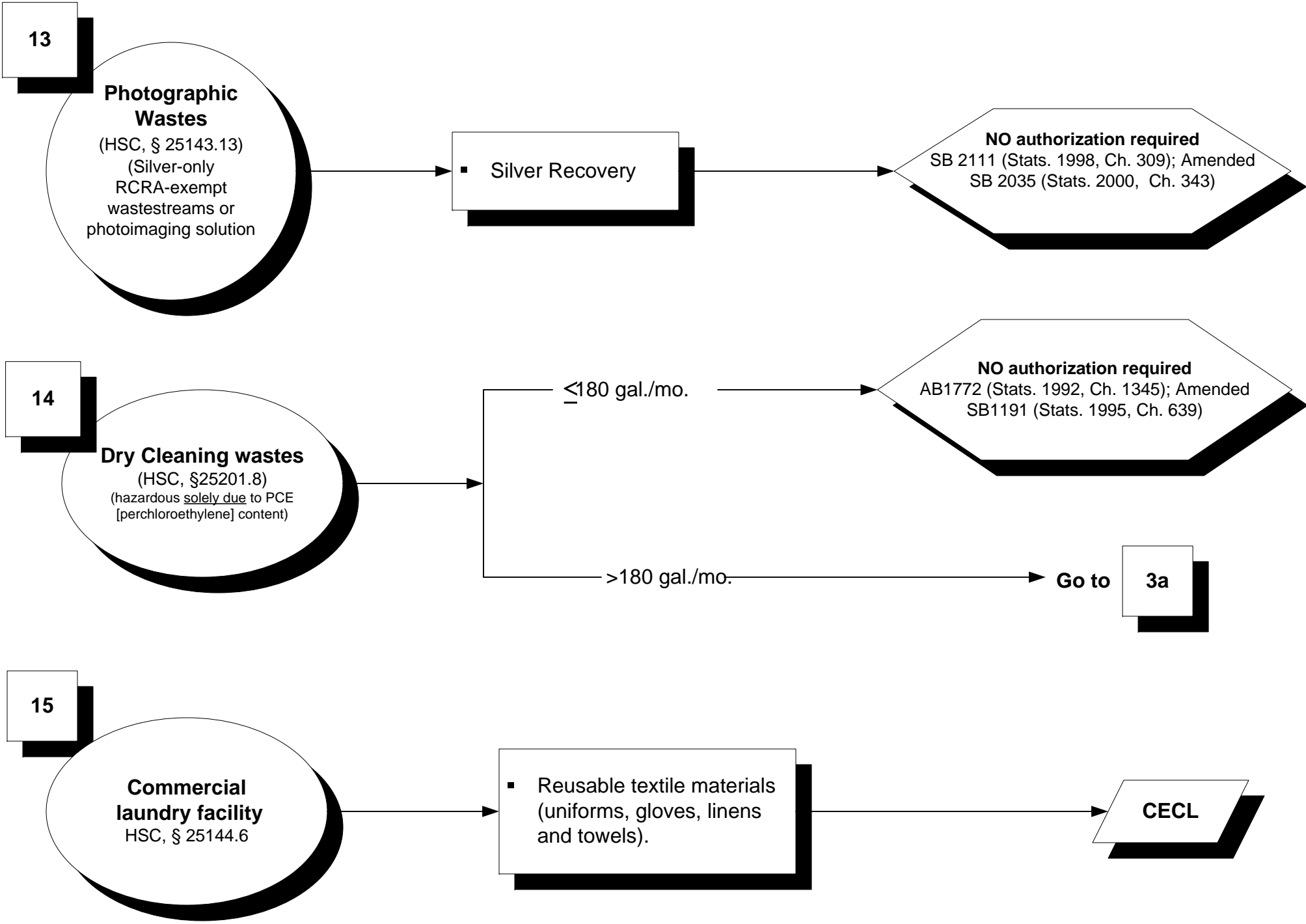

16a

Laboratory Waste
HSC § 25200.3.1

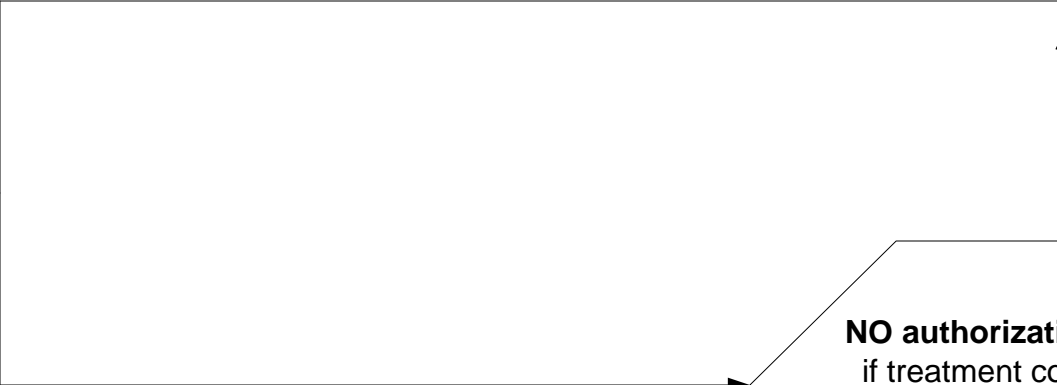

CESW

NO authorization required
if treatment complies with
HSC, § 25200.3.1
AB 966 (Stats. 1998, Ch. 506)

16b

**Quality Control or
Quality Assurance
Laboratory**
(HSC, § 25201.5(c)(8))

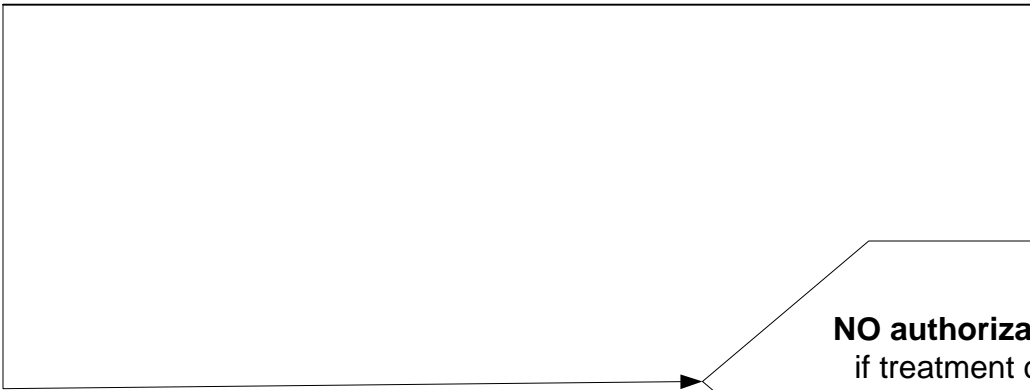

CESW

NO authorization required
if treatment complies with
HSC § 25200.3.1
AB 966 (Stats. 1998, Ch. 506)

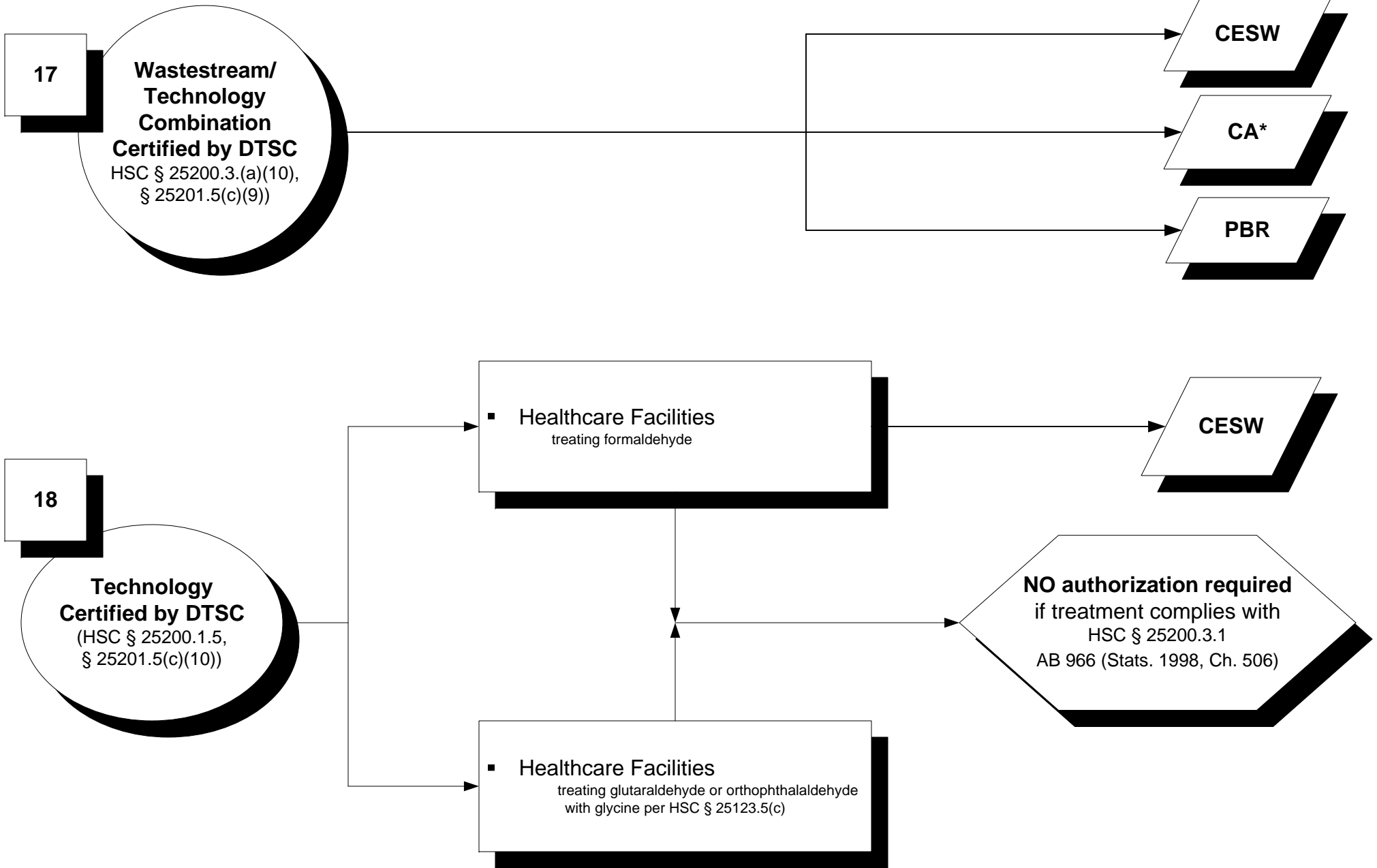

*Must be hazardous solely due to this characteristic

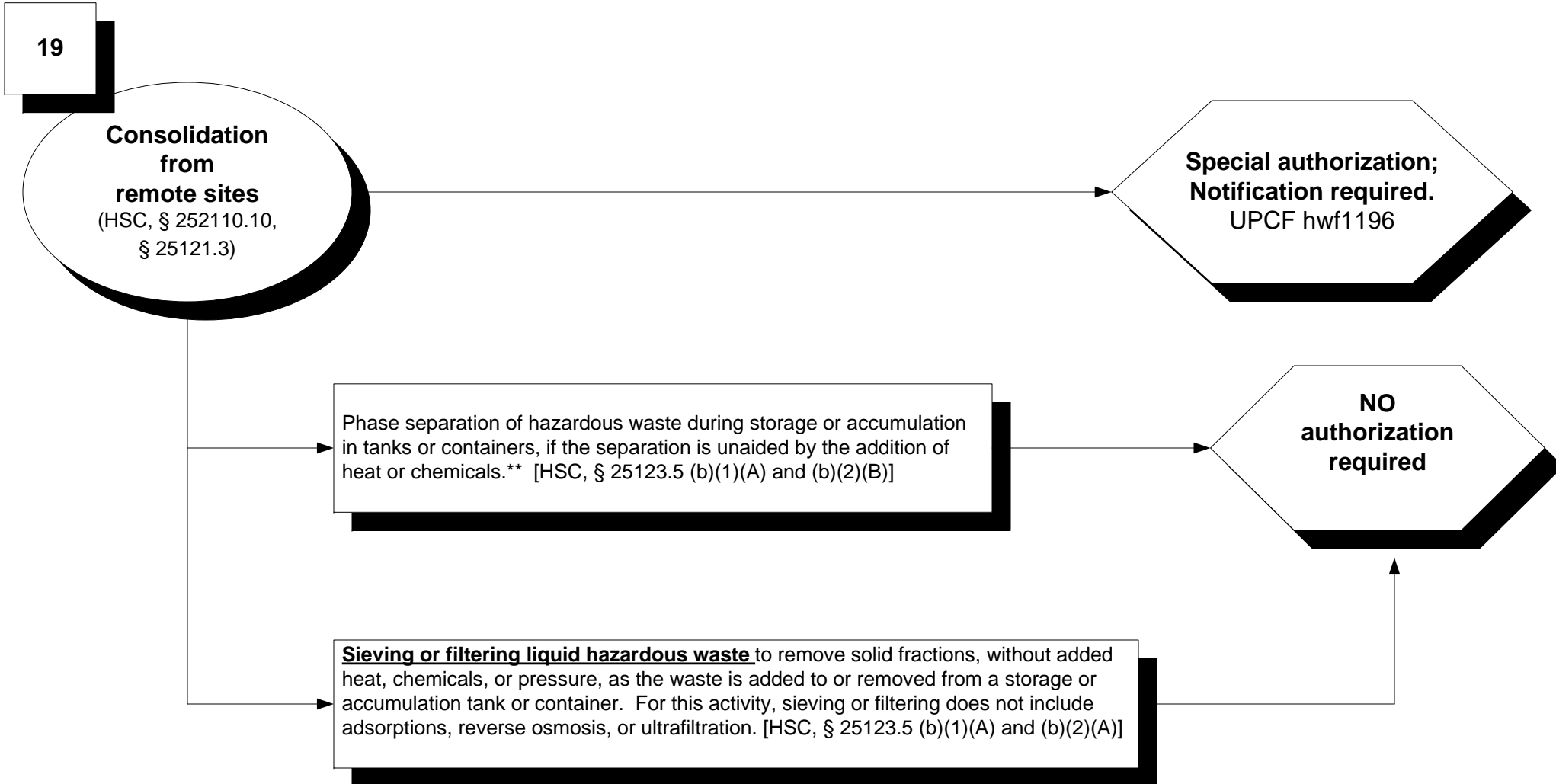

**Containers must be closed except when adding/removing hazardous wastes (T22, § 66265.173)

Cyanide Treatment (T22 § 67450.11 (d)(2))

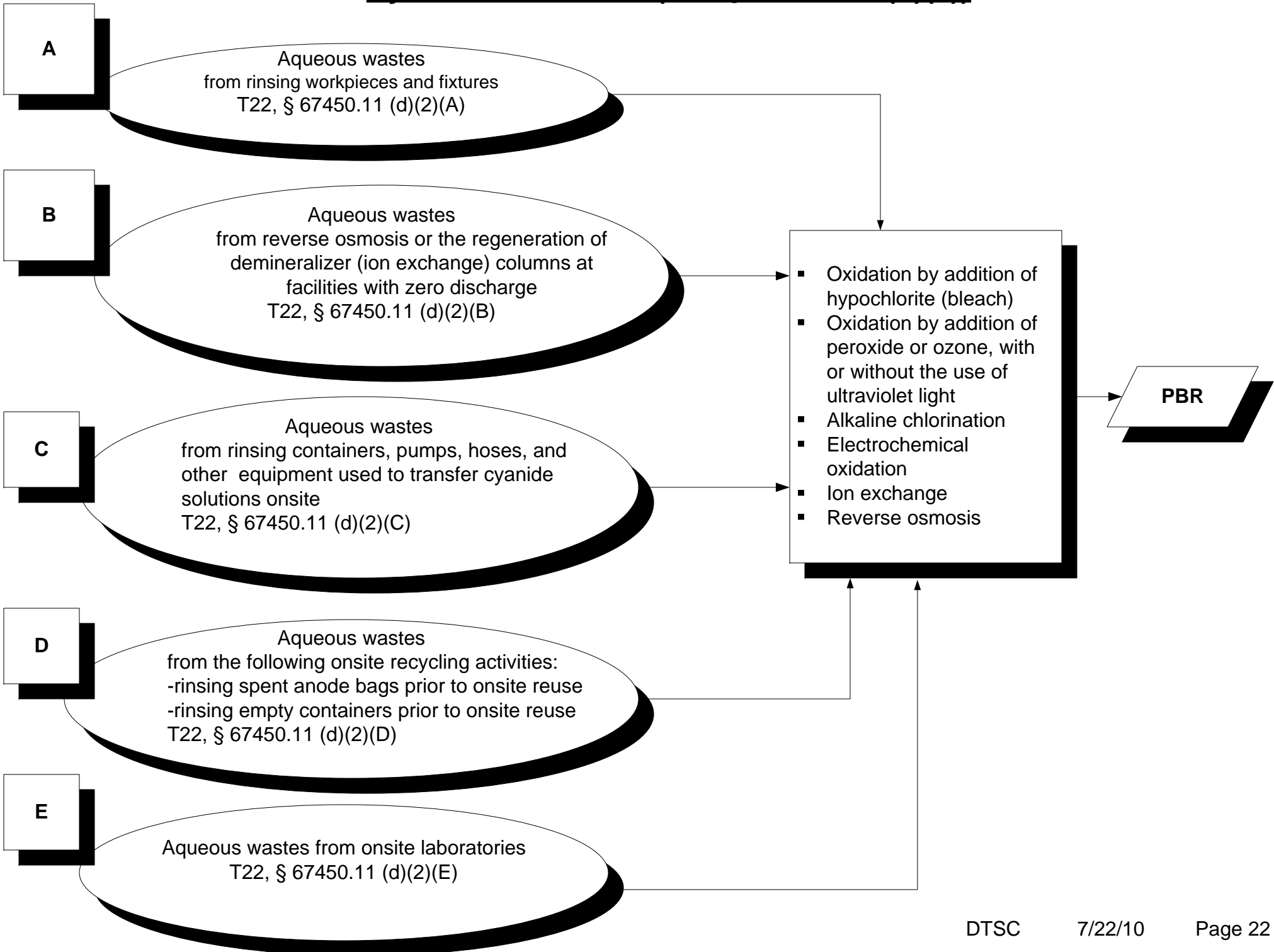

Cyanide Treatment (T22, § 67450.11 (d)(2))

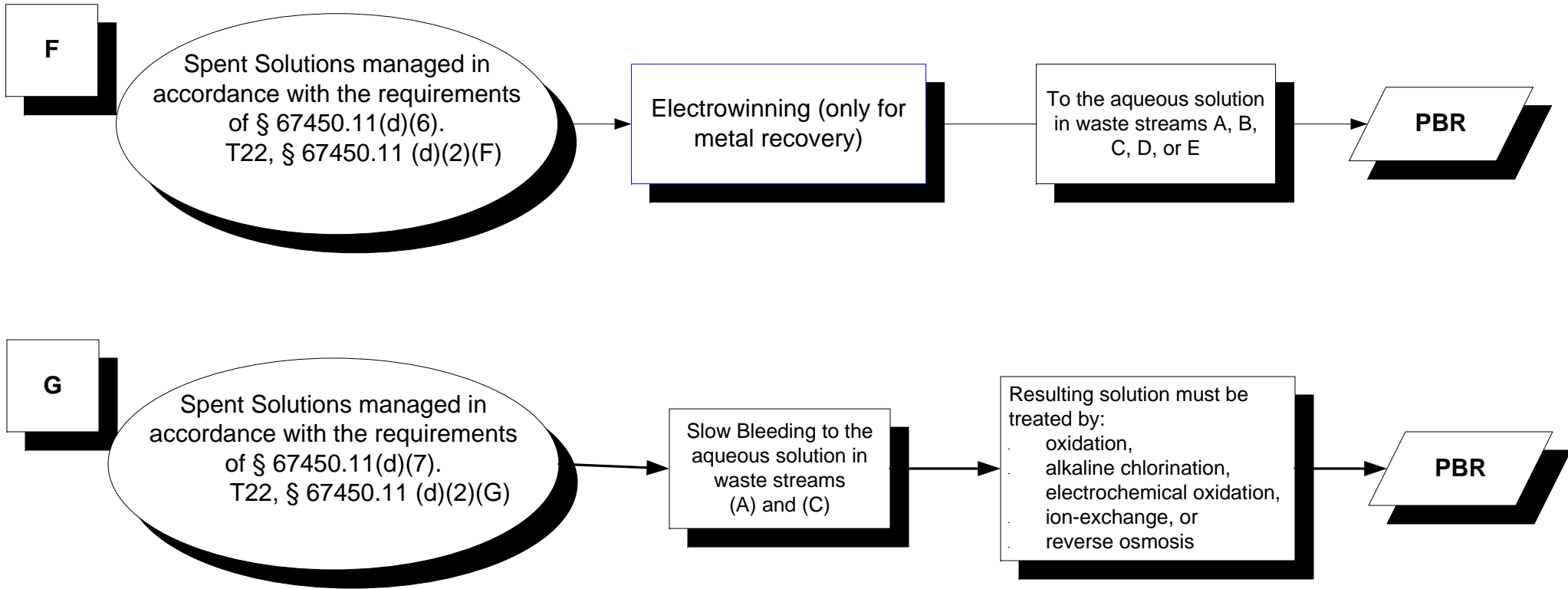

Additional Requirements for Dilution of Process Solutions:

- Total cyanide concentration limited to 5,000 mg/l after dilution
- Written approval from the agency operating the POTW
- Waste analysis plan (cyanides)
- The residual solids removed are recycled by a facility that recovers metals including documentation
- By January 30 - Prepare justification statement when residuals are not recycled for the previous calendar year
- Records maintained at the facility for 3 years

For all Cyanide Treatments under PBR:

- Comply with Best Management Requirements
- Employee training (Initial and annual training to employees, who handle cyanide process solutions, cyanide rinse waters, or manage cyanide waste)
- Evaluate cyanide alternatives every 4 years

Transportable Treatment Units

Note - SUBMIT TTU NOTIFICATIONS TO DTSC, NOT TO THE CUPA.

WASTE STREAM &
TREATMENT PROCESSES

AUTHORIZATION
OPTIONS

NOTIFICATION
FORMS

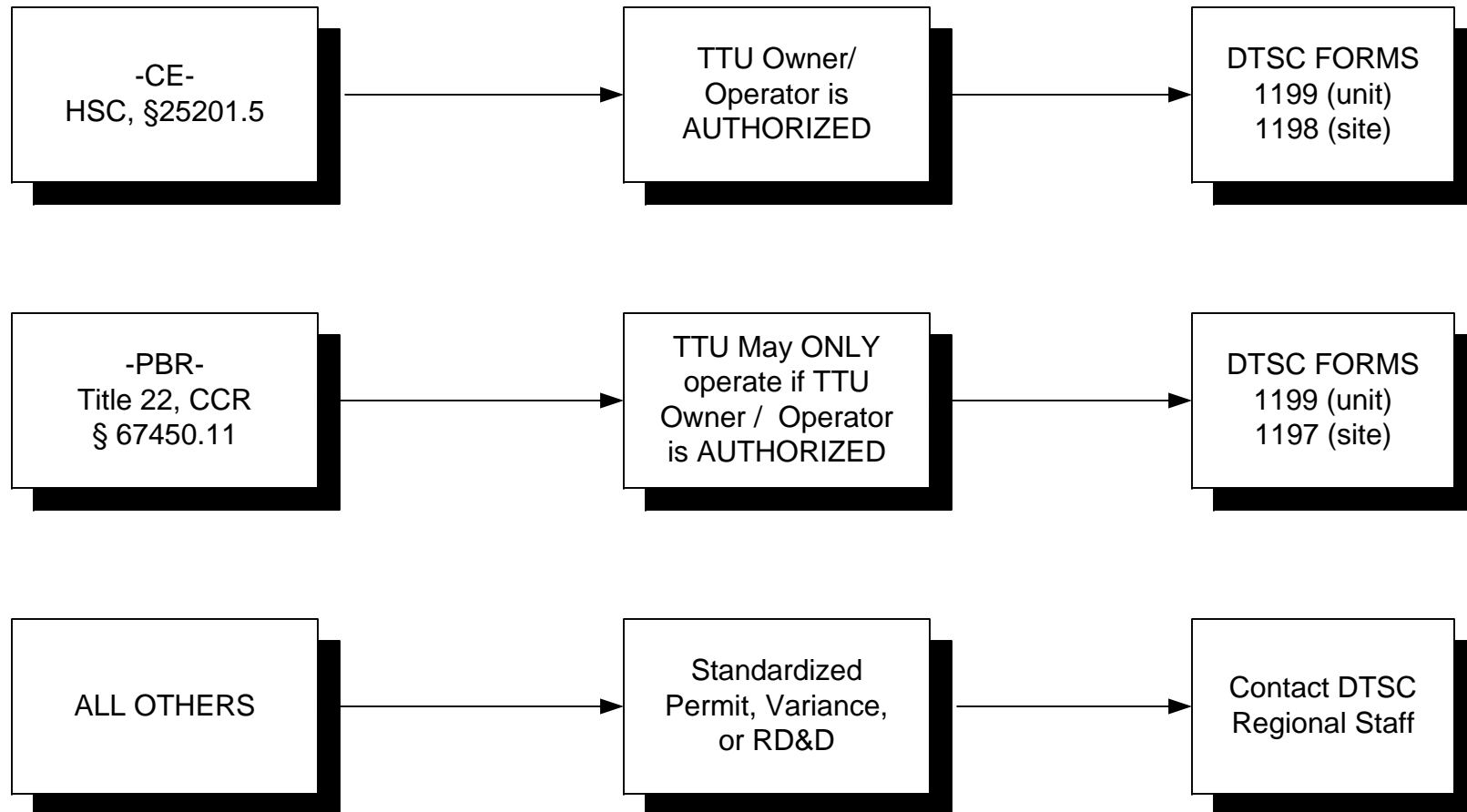

PBR Collection Facilities

